

Unit 8.1 Apply Triangle Sum Properties PRACTICE

Find the measure of each angle indicated.

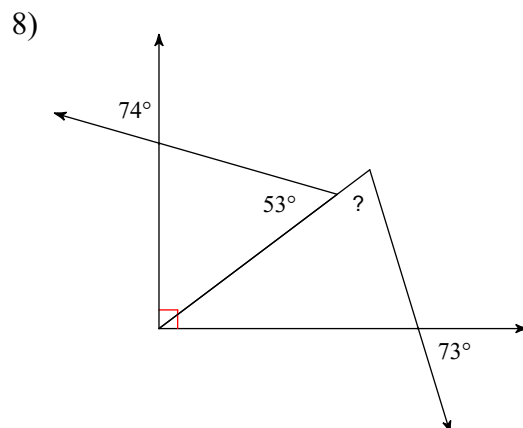

9)

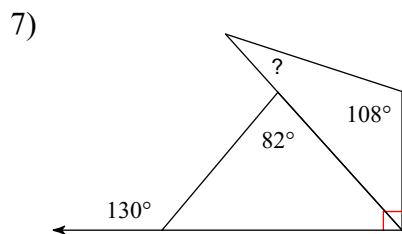
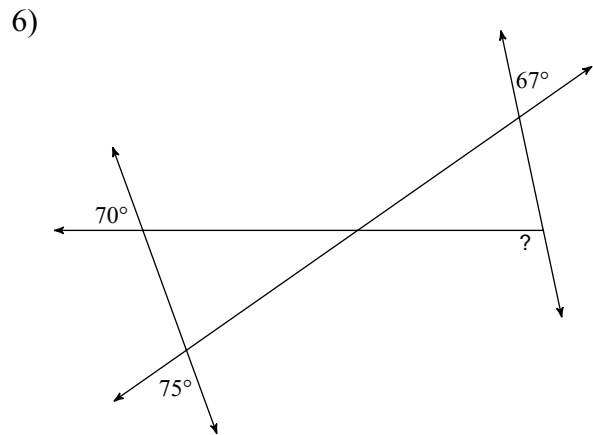
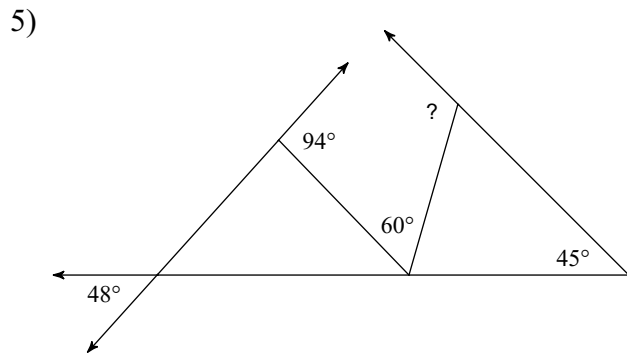
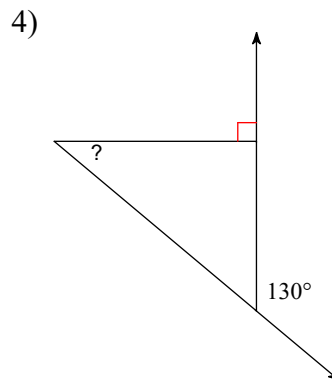
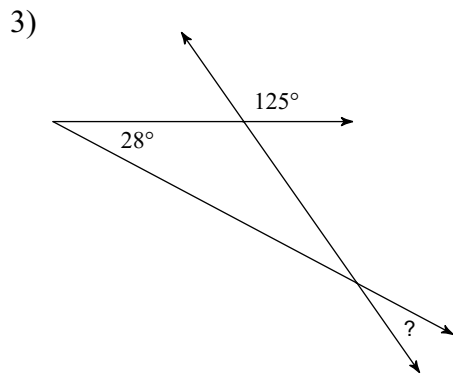
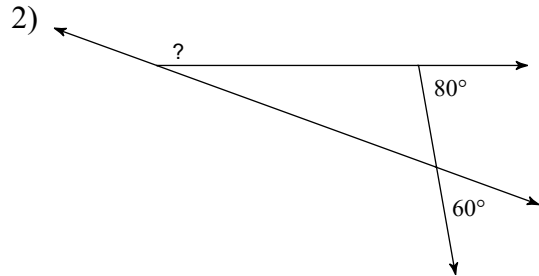
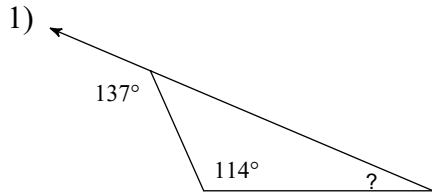
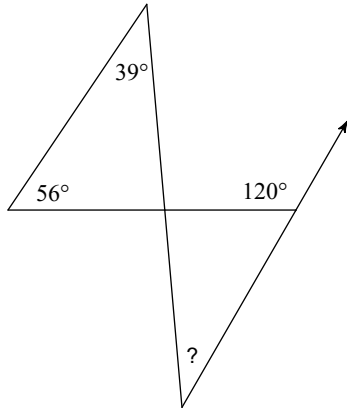

10)

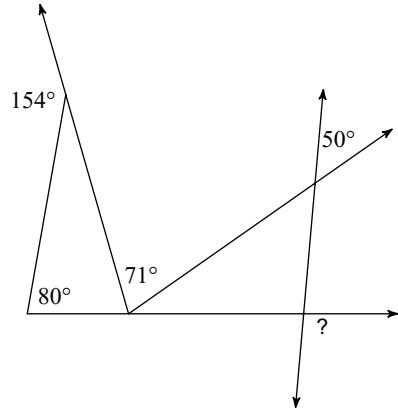

11)

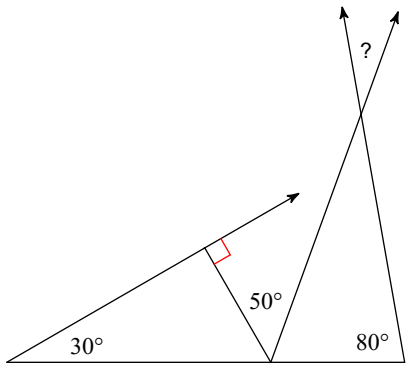

12)

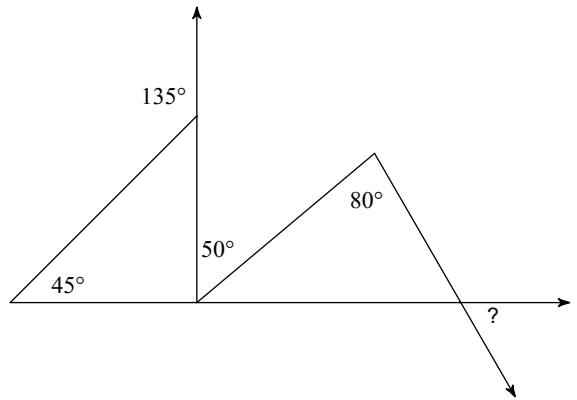

13)

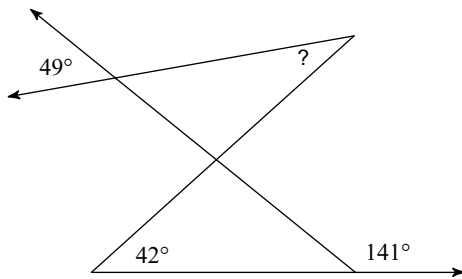

14)

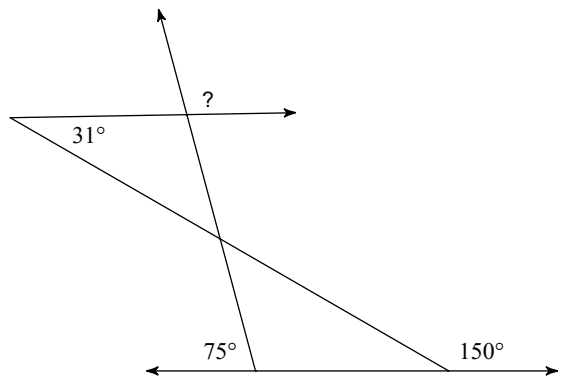

15)

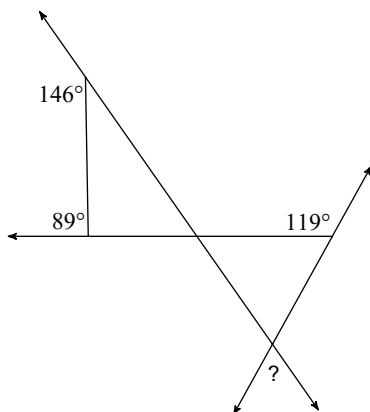

16)

