

PRACTICE Test 8 Surface area and Volume

Find the surface area of each figure. Round your answers to the nearest whole, if necessary.

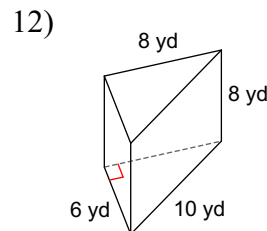
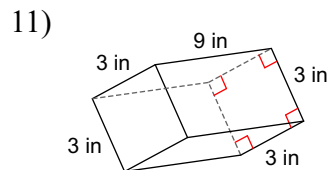
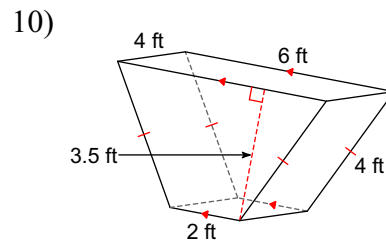
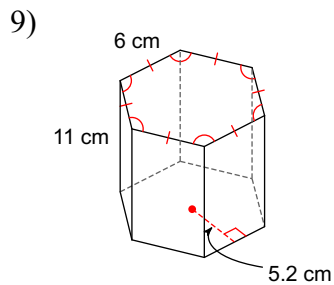
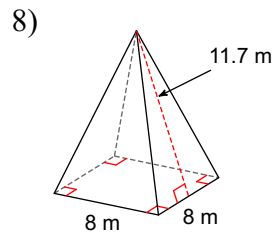
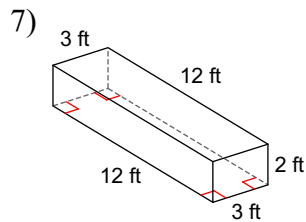
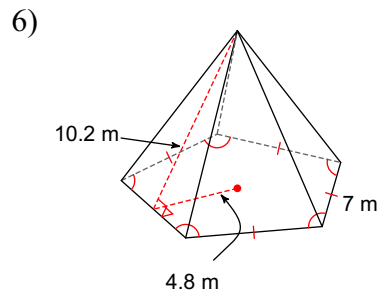
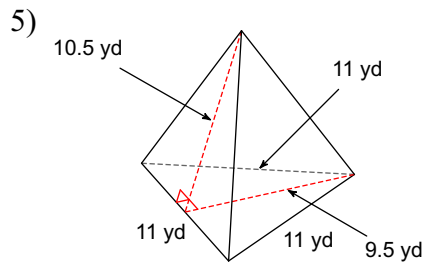
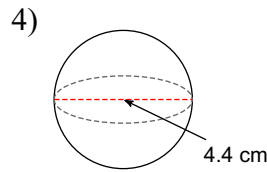
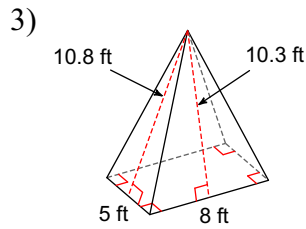
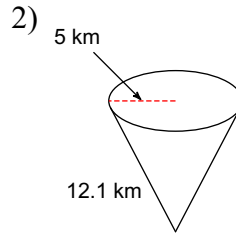
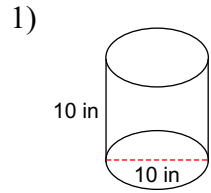

Find the volume of each figure. Round your answers to the nearest whole, if necessary.

13)

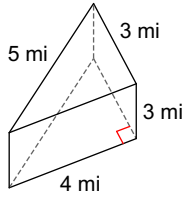

14)

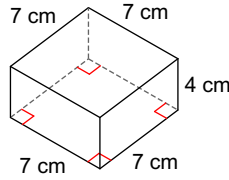

15)

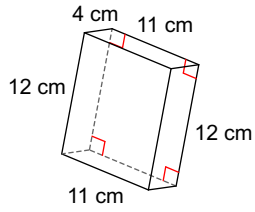

16)

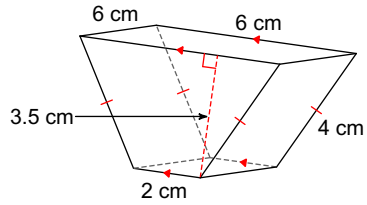

17)

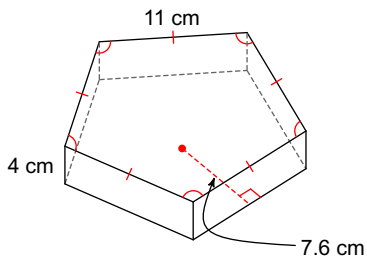

18)

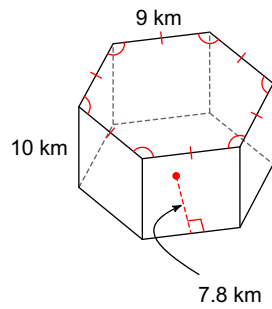

19)

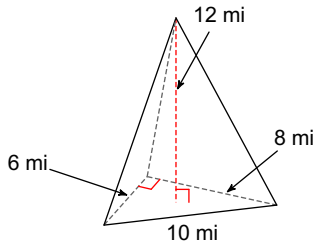

20)

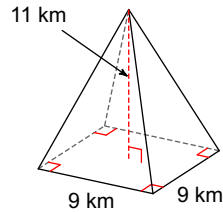

21)

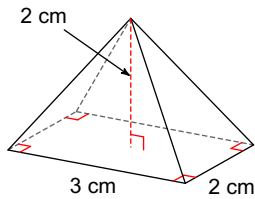

22)

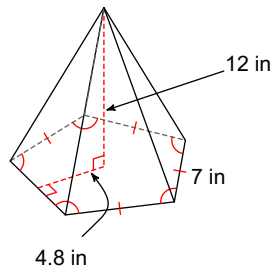

23)

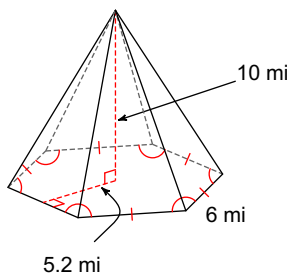

24)

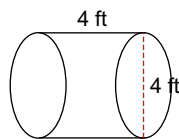

25)

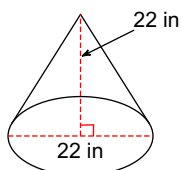

26)

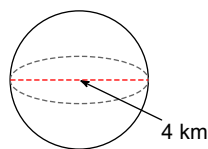

PRACTICE Test 8 Surface area and Volume

Find the surface area of each figure. Round your answers to the nearest whole, if necessary.

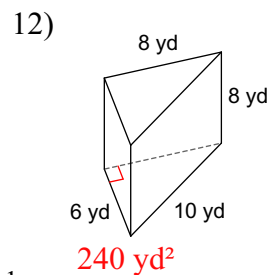
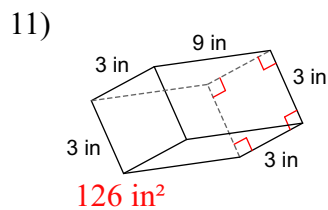
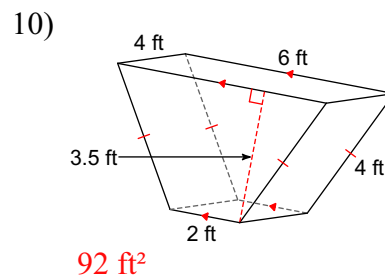
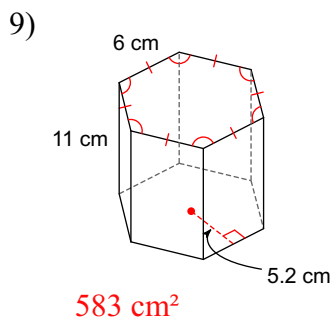
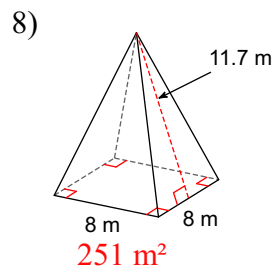
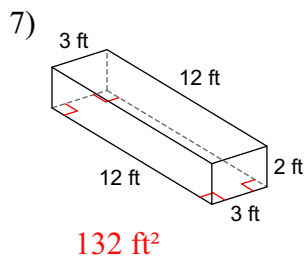
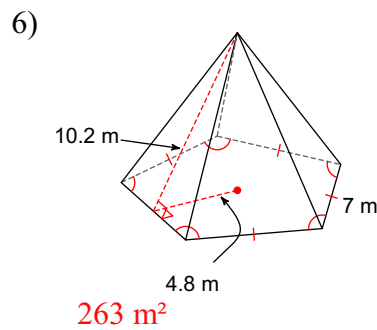
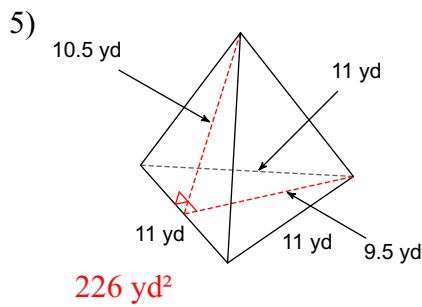
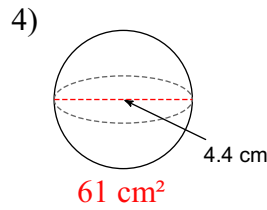
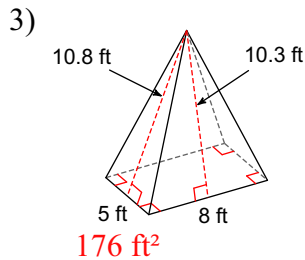
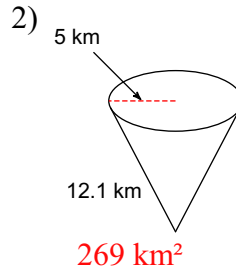
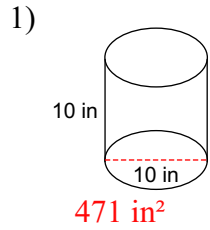

Find the volume of each figure. Round your answers to the nearest whole, if necessary.

